



**SKAVA**®



## Digital Switches



“Xpress is a digital way to operate your switches. Let's go digital, let's go modern, let's go to the next level, the Xpress way.”

“The Xpress fan regulator is the modern way to regulate the speed of your fans. It comes with added feature of long-press to jump from minimum or maximum speed. Let's control the fan speed the Xpress way.”

## Digital Fan Regulator



Ab India  
Karega Xpress

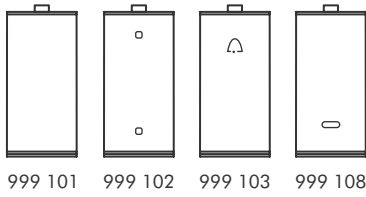

	Antique White	Graphite Grey	Charcoal Black	Std./Master
	Cat No.	Cat No.	Cat No.	Pkg.
<b>10Ax - Switches 240V ~ 1 Module - X1 Series</b>				
10Ax 1 way Switch	999 101	888 101	666 101	20/600
10Ax 2 way Switch	999 102	888 102	666 102	20/400
10Ax Bell Switch	999 103	888 103	666 103	20/400
10Ax 1 way Switch - X3	999 108	888 108	666 108	20/600

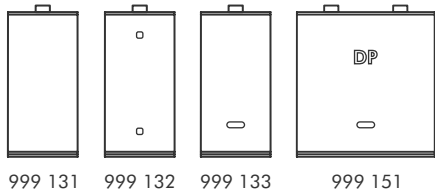

<b>20A - Switches / 32A DP Switch 240V ~ 1 Module &amp; 2 Module - X1 Series</b>				
20A 1 way Switch	999 131	888 131	666 131	20/400
20A 2 way Switch	999 132	888 132	666 132	20/200
20A 1 way Switch with LED	999 133	888 133	666 133	20/400
32A DP Switch with LED Heavy Duty	999 151	888 151	666 151	10/200

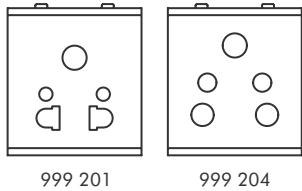

<b>10A Sockets - with Safety Shutters - 2 Module</b>				
10A Multi Pin Socket with Child Safety Shutter	999 201	888 201	666 201	10/300
10A 5 Pin Socket with Child Safety Shutter	999 204	888 204	666 204	10/300

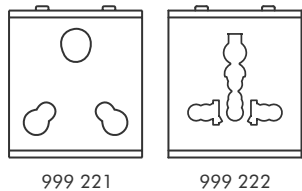

<b>6 &amp; 16A Multi Socket / 13A Int. Socket - with Safety Shutters - 2 Module</b>				
6A & 16A Multi Socket with Child Safety Shutter <b>New</b>	999 221	888 221	666 221	10/200
13A Int. Socket with complete closed shutter suitable for all global plugs <b>New</b>	999 222	888 222	666 222	10/200

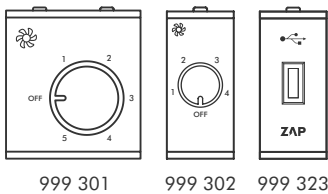

<b>Fan Regulator / Zap USB Charger - 1 Module &amp; 2 Module</b>				
5 Step Fan Regulator (360° Rotatory)	999 301	888 301	666 301	10/200
4 Step Fan Regulator (360° Rotatory)	999 302	888 302	666 302	10/200
ZAP USB Fast Charger 2.1A	999 323	888 323	666 323	10/100

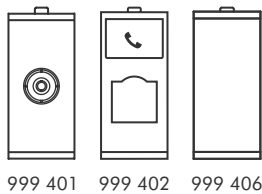

<b>TV Socket / Telephone Jack / Blank Plate - 1 Module</b>				
TV Socket - Coaxial	999 401	888 401	666 401	20/200
Telephone Jack - RJ11 (Shuttered with Name Plate)	999 402	888 402	666 402	20/200
Blank Plate	999 406	888 406	666 406	50/500

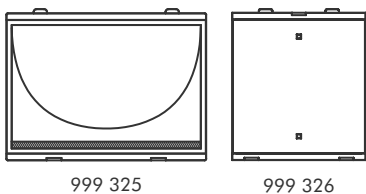

<b>3M &amp; 2M LED Night Lamp - Diffused Warm White</b>				
LED Night Lamp - 3M	999 325	888 325	666 325	10/100
LED Night Lamp - 2M (2 way Lighting) <b>New</b>	999 326	888 326	666 326	10/100

	Antique White	Graphite Grey	Charcoal Black	Std./Master
	Cat No.	Cat No.	Cat No.	Pkg.

**10Ax - Switches 240V ~ Bell switch w LED - 1 Module & 2 Module - X1 Series**

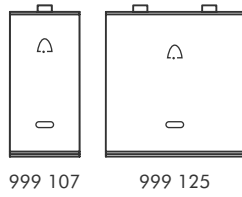

Bell Switch with LED - 1M	999 107	888 107	666 107	20/200
Bell Switch with LED - 2M	999 125	888 125	666 125	10/200

**3 Pin socket / 2 Pin Socket / LED Indicator - 1 Module & 2 Module**

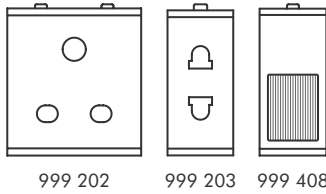

10A 3 Pin Socket with Child Safety Shutter	999 202	888 202	666 202	10/300
6A 2 Pin Socket with Child Safety Shutter	999 203	888 203	666 203	20/200
LED Indicator with reflector	999 408	888 408	666 408	20/200

**Light Dimmer - 1 Module & 2 Module**

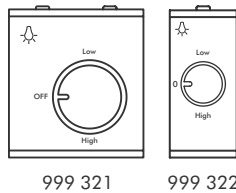

Light Dimmer 200W - 2M	999 321	888 321	666 321	10/100
Light Dimmer 200W - 1M	999 322	888 322	666 322	10/100

**Fuse / Cord Outlet / Cat 5E / Cat 6 - 1 Module**

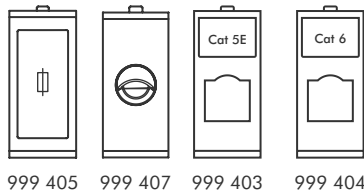

10A Kit Kat Fuse	999 405	888 405	666 405	10/100
Cord Outlet - 360° rotatory	999 407	888 407	666 407	20/200
Comp. Jack RJ 45 - Cat 5E (Shuttered with Name Plate)	999 403	888 403	666 403	20/200
Comp. Jack RJ 45 - Cat 6 (Shuttered with Name Plate)	999 404	888 404	666 404	20/200

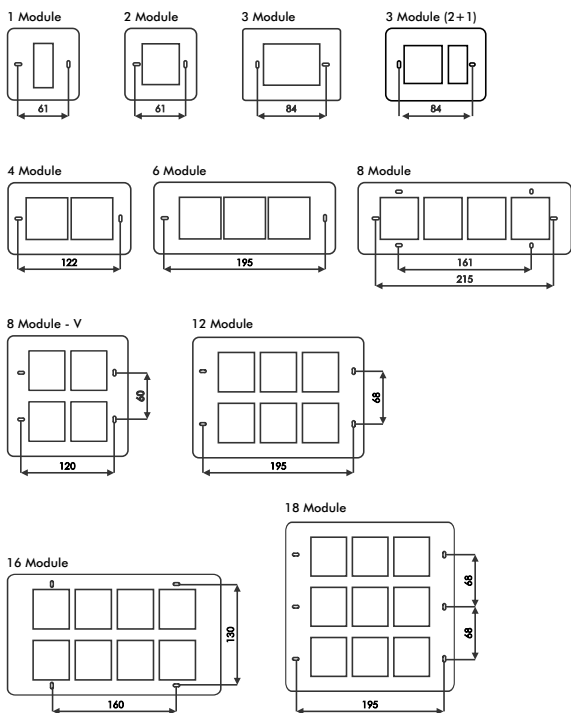

Product Name	Antique White	Std. Pkg.
	Cat No.	
<b>White cover plates with support frames</b>		
1 Module cover plates with support frames	999 601	10/100
2 Module cover plates with support frames	999 602	10/100
3 Module cover plates with support frames	999 603	10/100
3 Module cover plates with support frames (2+1)	999 761	10/100
4 Module cover plates with support frames	999 604	10/100
6 Module cover plates with support frames	999 605	10/100
8 Module cover plates with support frames (H)	999 606	10/100
8 Module cover plates with support frames (V)	999 607	10/100
12 Module cover plates with support frames	999 608	10/100
16 Module cover plates with support frames	999 609	5/50
18 Module cover plates with support frames	999 610	5/50

**Antique White**
**Graphite Grey**
**Charcoal Black**
**Std./Master**

Cat No.

Cat No.

Cat No.

Pkg.

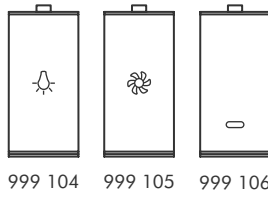
**10Ax - Switches 240V ~ Mark / LED - 1 Module - X1 Series**

10Ax 1 way Lamp Switch	999 104	888 104	666 104	20/200
10Ax 1 way Fan Switch	999 105	888 105	666 105	20/200
10Ax 1 way Switch with LED	999 106	888 106	666 106	20/200

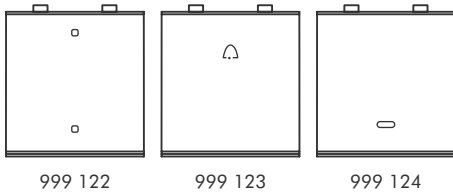
**10Ax - Switches 240V ~ 2 Module - X1 Series**

10Ax 1 way Switch	999 121	888 121	666 121	10/100
10Ax 2 way Switch	999 122	888 122	666 122	10/100
10Ax Bell Switch	999 123	888 123	666 123	10/100
10Ax 1 way Switch with LED	999 124	888 124	666 124	10/100

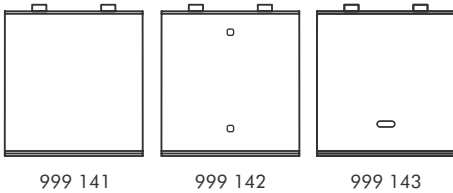
**20A - Switches 240V ~ 2 Module - X1 Series**

20A 1 way Switch	999 141	888 141	666 141	10/100
20A 2 way Switch	999 142	888 142	666 142	10/100
20A 1 way Switch with LED	999 143	888 143	666 143	10/100

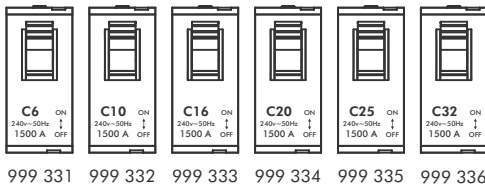
**Tiny Trip Single Pole MCB - C Curve - 1 Module**

C 6A SP MCB	999 331	888 331	666 331	10/100
C 10A SP MCB	999 332	888 332	666 332	10/100
C 16A SP MCB	999 333	888 333	666 333	10/100
C 20A SP MCB	999 334	888 334	666 334	10/100
C 25A SP MCB	999 335	888 335	666 335	10/100
C 32A SP MCB	999 336	888 336	666 336	10/100

**Tiny Trip Double Pole MCB - C Curve - 2 Module**

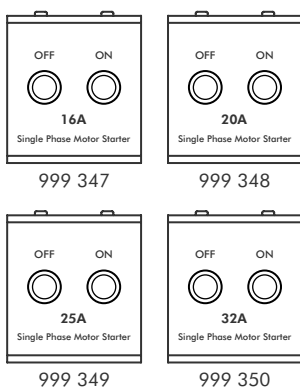

C 6A DP MCB	999 341	888 341	666 341	10/100
C 10A DP MCB	999 342	888 342	666 342	10/100
C 16A DP MCB	999 343	888 343	666 343	10/100
C 20A DP MCB	999 344	888 344	666 344	10/100
C 25A DP MCB	999 345	888 345	666 345	10/100
C 32A DP MCB	999 346	888 346	666 346	10/100

**Single Phase Motor Starter - 2 Module New**

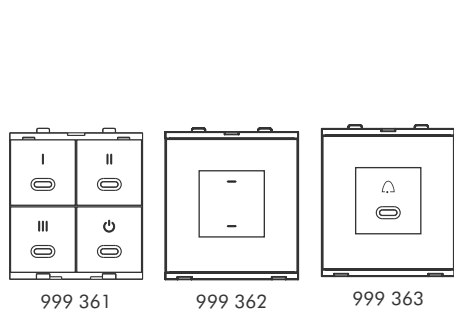
16A Motor Starter	999 347	888 347	666 347	10/100
20A Motor Starter	999 348	888 348	666 348	10/100
25A Motor Starter	999 349	888 349	666 349	10/100
32A Motor Starter	999 350	888 350	666 350	10/100

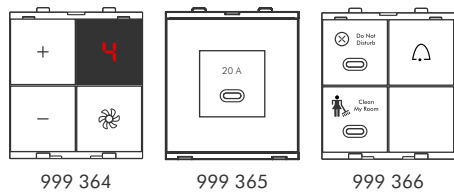

	Antique White Cat No.	Graphite Grey Cat No.	Charcoal Black Cat No.	Std./Master Pkg.
<b>Digital - 6A Switches 240V ~ 2 Module</b>				
6A 3 Switches + Master with LED	999 361	888 361	666 361	1/3
6A 2 way switch	999 362	888 362	666 362	1/3
6A Bell switch with LED	999 363	888 363	666 363	1/3



<b>Digital - Fan Regulator / 20A Switch 240V / DND-CMR Unit - 2 Module</b>				
4 Step Fan Regulator-150W with Display	999 364	888 364	666 364	1/3
20A Switch with LED	999 365	888 365	666 365	1/3
DND / CMR Unit (Do not Disturb / Clean My Room)	999 366	888 366	666 366	1/3

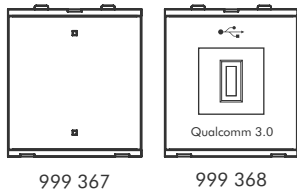

<b>Touch Night Lamp - Diffused Warm White / Qualcomm USB Charger - 2 Module <span style="color: red;">Coming Soon</span></b>				
LED Touch Night Lamp	999 367	888 367	666 367	1/3
Qualcomm USB 3.0 charger Single Port	999 368	888 368	666 368	1/3

# Hospitality

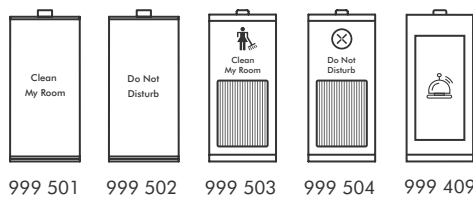

<b>Hospitality Range - 1 Module</b>				
10Ax CMR Switch	999 501	888 501	666 501	20/200
10Ax DND Switch	999 502	888 502	666 502	20/200
CMR Indicator	999 503	888 503	666 503	20/200
DND Indicator	999 504	888 504	666 504	20/200
Buzzer (Do not Disturb / Clean My Room)	999 409	888 409	666 409	10/100

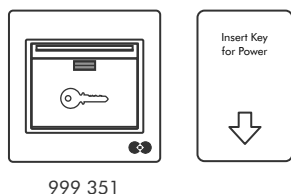

<b>25A Smart Card Switch - 2 Module</b>				
25A Smart Card Switch with Smart Card (Electronic Switch with Exit Delay)	999 351	888 351	666 351	5/50

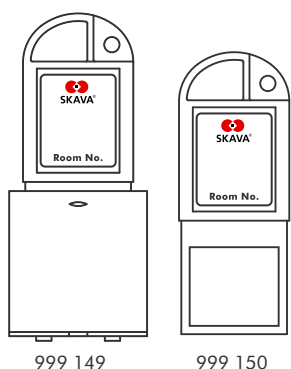

<b>20A Control Switch - 2 Module</b>				
20A DP Switch with Key Tag	999 149	888 149	666 149	10/100
Key Tag only	999 150	888 150	666 150	10/100



# LET'S GO COLOR

“ A color defines your taste and also enhances the interiors. So we have taken that extra effort to make our plates look more vibrant & colorful. Our paints are specially developed by a Japanese Technology, which makes them scratch proof and long lasting. ”

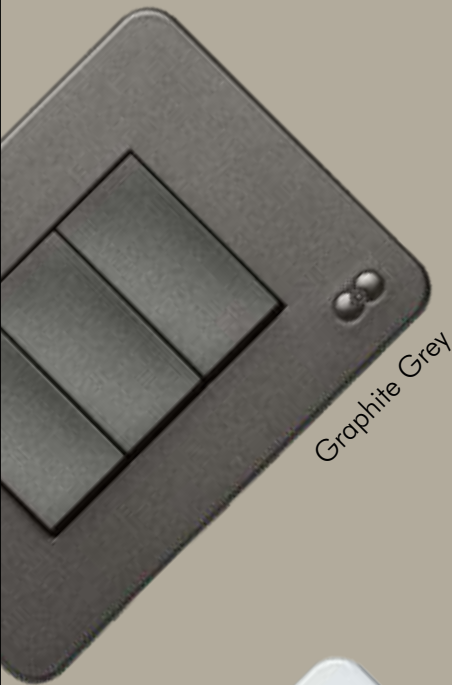
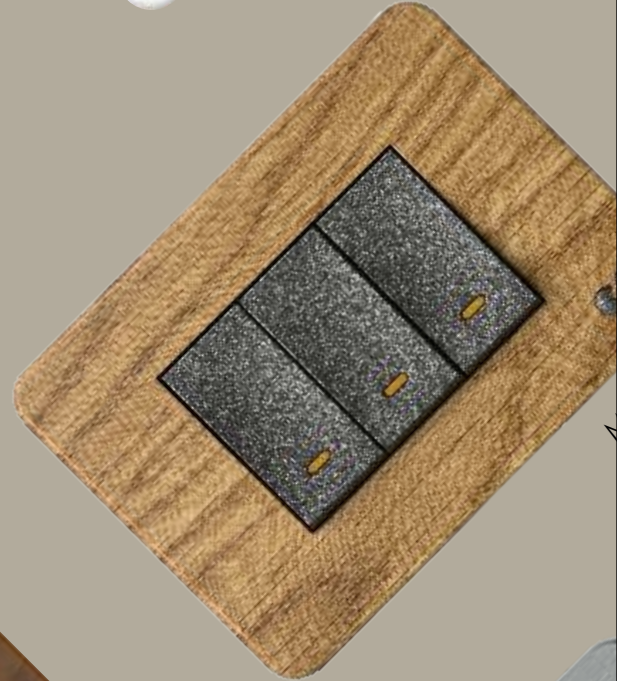





Charcoal Black

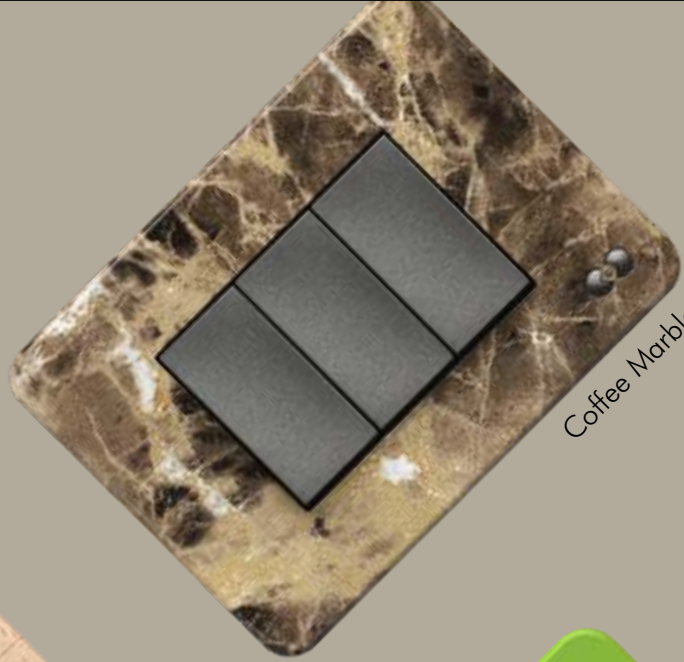

Coffee Marble



Maple Oak



Italian Marble



Android Green



Brushed Aluminium



Torch Red



Simple Orange

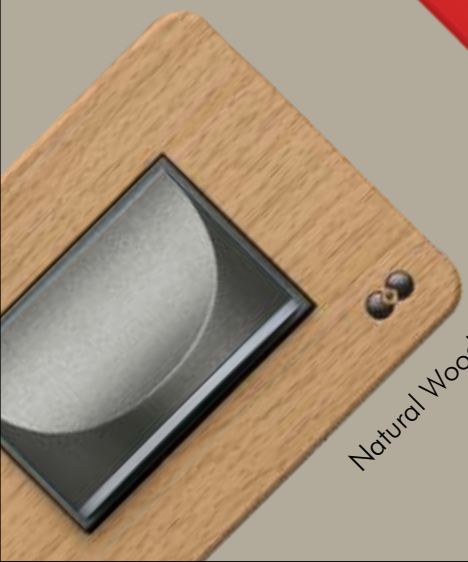

Natural Wood

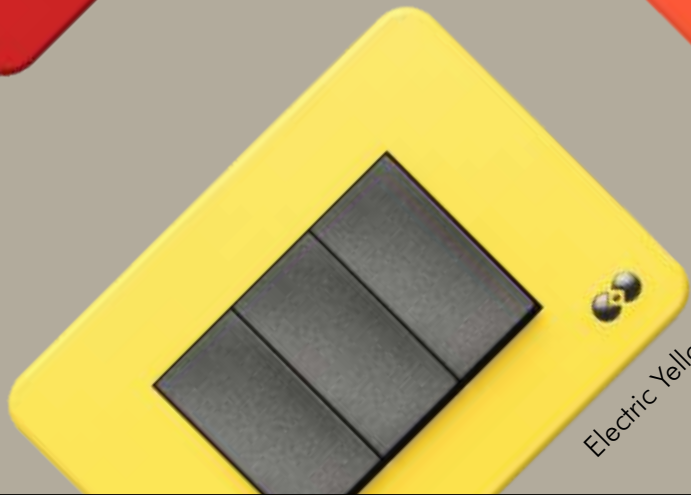

Electric Yellow

## Combi Pack (Support Frame + Cover Plate)

Modules	1M	2M	3M	3M (2+1)	4M	6M	8M	8M - V	12M	16M	18M
	Cat No.	Cat No.	Cat No.	Cat No.	Cat No.	Cat No.	Cat No.	Cat No.	Cat No.	Cat No.	Cat No.
Colors	MRP ₹	MRP ₹	MRP ₹	MRP ₹	MRP ₹	MRP ₹	MRP ₹	MRP ₹	MRP ₹	MRP ₹	MRP ₹
<b>White cover plates with support frames</b>											
<b>Antique White with LED</b>	999 701	999 702	999 703	999 762	999 704	999 705	999 706	999 707	999 708	999 709	999 710
Std./Master	10/100	10/100	10/100	10/100	10/100	10/100	10/100	10/100	10/100	5/50	5/50
<b>Metallic cover plates with support frames</b>											
<b>Warm Gold with LED</b>	999 611	999 612	999 613	999 764	999 614	999 615	999 616	999 617	999 618	999 619	999 620
<b>Quick Silver with LED</b>	999 621	999 622	999 623	999 765	999 624	999 625	999 626	999 627	999 628	999 629	999 630
<b>Graphite Grey with LED</b>	999 631	999 632	999 633	999 766	999 634	999 635	999 636	999 637	999 638	999 639	999 640
<b>Solid cover plates with support frames</b>											
<b>Torch Red with LED</b>	999 641	999 642	999 643	999 768	999 644	999 645	999 646	999 647	999 648	999 649	999 650
<b>Android Green with LED</b>	999 651	999 652	999 653	999 769	999 654	999 655	999 656	999 657	999 658	999 659	999 660
<b>Simple Orange with LED</b>	999 661	999 662	999 663	999 770	999 664	999 665	999 666	999 667	999 668	999 669	999 670
<b>Electric Yellow with LED</b>	999 671	999 672	999 673	999 771	999 674	999 675	999 676	999 677	999 678	999 679	999 680
<b>Charcoal Black with LED</b>	999 741	999 742	999 743	999 772	999 744	999 745	999 746	999 747	999 748	999 749	999 750
<b>Natural cover plates with support frames</b>											
<b>Natural Wood with LED</b>	999 681	999 682	999 683	999 773	999 684	999 685	999 686	999 687	999 688	999 689	999 690
<b>African Oak with LED</b>	999 691	999 692	999 693	999 774	999 694	999 695	999 696	999 697	999 698	999 699	999 700
<b>Italian Marble with LED</b>	999 711	999 712	999 713	999 775	999 714	999 715	999 716	999 717	999 718	999 719	999 720
<b>Coffee Marble with LED</b>	999 721	999 722	999 723	999 776	999 724	999 725	999 726	999 727	999 728	999 729	999 730
<b>Maple Oak with LED</b>	999 751	999 752	999 753	999 777	999 754	999 755	999 756	999 757	999 758	999 759	999 760
<b>Brushed Aluminium with LED</b>	999 781	999 782	999 783	999 778	999 784	999 785	999 786	999 787	999 788	999 789	999 790
Std./Master	5/50	5/50	5/50	5/50	5/50	5/50	5/50	5/50	5/50	5/50	5/50

Individual Pack (Support Frame & Cover Plate)

Modules	1M	2M	3M	3M (2+1)	4M	6M	8M	8M - V	12M	16M	18M
	Cat No.	Cat No.	Cat No.	Cat No.	Cat No.	Cat No.	Cat No.	Cat No.	Cat No.	Cat No.	Cat No.
Colors	MRP ₹	MRP ₹	MRP ₹	MRP ₹	MRP ₹	MRP ₹	MRP ₹	MRP ₹	MRP ₹	MRP ₹	MRP ₹
<b>Support Frame</b>											
<b>Support Frame with LED</b>	999 791	999 792	999 793	999 763	999 794	999 795	999 796	999 797	999 798	999 799	999 800
Std./Master	10/100	10/100	10/100	10/100	10/100	10/100	10/100	10/100	10/100	5/50	5/50
<b>Metallic cover plates</b>											
<b>Warm Gold</b>	555 611	555 612	555 613	555 764	555 614	555 615	555 616	555 617	555 618	555 619	555 620
<b>Quick Silver</b>	555 621	555 622	555 623	555 765	555 624	555 625	555 626	555 627	555 628	555 629	555 630
<b>Graphite Grey</b>	555 631	555 632	555 633	555 766	555 634	555 635	555 636	555 637	555 638	555 639	555 640
<b>Solid cover plates</b>											
<b>Torch Red</b>	555 641	555 642	555 643	555 768	555 644	555 645	555 646	555 647	555 648	555 649	555 650
<b>Android Green</b>	555 651	555 652	555 653	555 769	555 654	555 655	555 656	555 657	555 658	555 659	555 660
<b>Simple Orange</b>	555 661	555 662	555 663	555 770	555 664	555 665	555 666	555 667	555 668	555 669	555 670
<b>Electric Yellow</b>	555 671	555 672	555 673	555 771	555 674	555 675	555 676	555 677	555 678	555 679	555 680
<b>Charcoal Black</b>	555 741	555 742	555 743	555 772	555 744	555 745	555 746	555 747	555 748	555 749	555 750
<b>Natural cover plates</b>											
<b>Natural Wood</b>	555 681	555 682	555 683	555 773	555 684	555 685	555 686	555 687	555 688	555 689	555 690
<b>African Oak</b>	555 691	555 692	555 693	555 774	555 694	555 695	555 696	555 697	555 698	555 699	555 700
<b>Italian Marble</b>	555 711	555 712	555 713	555 775	555 714	555 715	555 716	555 717	555 718	555 719	555 720
<b>Coffee Marble</b>	555 721	555 722	555 723	555 776	555 724	555 725	555 726	555 727	555 728	555 729	555 730
<b>Maple Oak</b>	555 751	555 752	555 753	555 777	555 754	555 755	555 756	555 757	555 758	555 759	555 760
<b>Brushed Aluminium</b>	555 781	555 782	555 783	555 778	555 784	555 785	555 786	555 787	555 788	555 789	555 790
Std./Master	10/100	10/100	10/100	10/100	10/100	10/100	10/100	10/100	10/100	10/100	10/100

New



Rating/Description	Modules	Cat No.	Std./Master
<b>Midtrip MCB - Single Pole (SP) - C Curve</b>			
C 6A	1	963 101	12/192
C 10A	1	963 102	12/192
C 16A	1	963 103	12/192
C 20A	1	963 104	12/192
C 25A	1	963 105	12/192
C 32A	1	963 106	12/192
C 40A	1	963 107	12/192
C 50A	1	963 108	12/192
C 63A	1	963 109	12/192



<b>Midtrip MCB - Double Pole (DP) - C Curve</b>			
C 6A	2	963 201	6/96
C 10A	2	963 202	6/96
C 16A	2	963 203	6/96
C 20A	2	963 204	6/96
C 25A	2	963 205	6/96
C 32A	2	963 206	6/96
C 40A	2	963 207	6/96
C 50A	2	963 208	6/96
C 63A	2	963 209	6/96



<b>Midtrip MCB - SPN - C Curve</b>			
C 6A	2	963 221	6/96
C 10A	2	963 222	6/96
C 16A	2	963 223	6/96
C 20A	2	963 224	6/96
C 25A	2	963 225	6/96
C 32A	2	963 226	6/96
C 40A	2	963 227	6/96
C 50A	2	963 228	6/96
C 63A	2	963 229	6/96



<b>Midtrip MCB - Triple Pole (TP) - C Curve</b>			
C 6A	3	963 301	4/64
C 10A	3	963 302	4/64
C 16A	3	963 303	4/64
C 20A	3	963 304	4/64
C 25A	3	963 305	4/64
C 32A	3	963 306	4/64
C 40A	3	963 307	4/64
C 50A	3	963 308	4/64
C 63A	3	963 309	4/64



<b>Midtrip MCB - Four Pole (FP) - C Curve</b>			
C 6A	4	963 401	3/48
C 10A	4	963 402	3/48
C 16A	4	963 403	3/48
C 20A	4	963 404	3/48
C 25A	4	963 405	3/48
C 32A	4	963 406	3/48
C 40A	4	963 407	3/48
C 50A	4	963 408	3/48
C 63A	4	963 409	3/48

# Low Voltage Switchgear



Rating/Description	Modules	Cat No.	Std./Master
<b>Midtrip MCB - TPN - C Curve</b>			
C 6A	4	963 421	3/48
C 10A	4	963 422	3/48
C 16A	4	963 423	3/48
C 20A	4	963 424	3/48
C 25A	4	963 425	3/48
C 32A	4	963 426	3/48
C 40A	4	963 427	3/48
C 50A	4	963 428	3/48
C 63A	4	963 429	3/48



Rating/Description	Modules	Cat No.	Std./Master
<b>Isolator</b>			
40A - DP	2	963 501	6/96
63A - DP	2	963 502	6/96
40A - FP	4	963 511	3/48
63A - FP	4	963 512	3/48



Rating/Description	Modules	Cat No.	Std./Master
<b>Residual Current Circuit Breaker (RCCB) - Double Pole with ISI mark</b>			
25A - 30mA	2	963 601	1/6
100mA	2	963 602	1/6
300mA	2	963 603	1/6
40A - 30mA	2	963 604	1/6
100mA	2	963 605	1/6
300mA	2	963 606	1/6
63A - 30mA	2	963 607	1/6
100mA	2	963 608	1/6
300mA	2	963 609	1/6



Rating/Description	Modules	Cat No.	Std./Master
<b>Residual Current Circuit Breaker (RCCB) - Four Pole with ISI mark</b>			
25A - 30mA	4	963 651	1/3
100mA	4	963 652	1/3
300mA	4	963 653	1/3
40A - 30mA	4	963 654	1/3
100mA	4	963 655	1/3
300mA	4	963 656	1/3
63A - 30mA	4	963 657	1/3
100mA	4	963 658	1/3
300mA	4	963 659	1/3



Rating/Description	Modules	Cat No.	Std./Master
<b>100% Shock Proof Distribution Box with ABS base &amp; PC frame</b>			
4 Way DB	4	972 101	1/20
6 Way DB	6	972 102	1/10
9 Way DB	9	972 103	1/10
12 Way DB	12	972 104	1/10
17 Way DB	17	972 105	1/5



Rating/Description	Modules	Cat No.	Std./Master
<b>Zen DB - Plastic Front with Metal Base DB</b>			
24 Way DB - Opaque	24	972 221	1/5
24 Way DB - Transparent	24	972 222	1/5

(Equivalent to 6 way TPN DB)

Each Distribution box comes with double action shutter, Jump link, Name plate & Installation screw set.

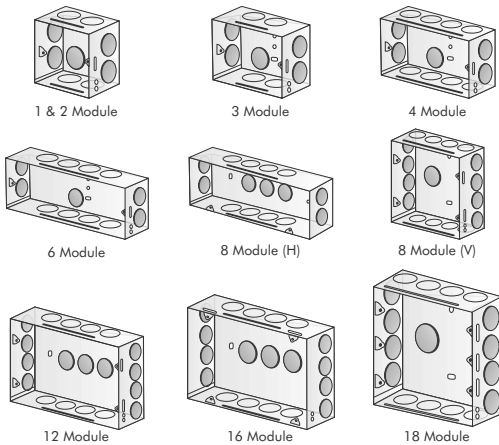

Product Name	Cat No.	Std. Pkg.
<b>Concealed Metal Gang Boxes</b>		
1 & 2 Module Metal Gang Box	999 801	10/120
3 Module Metal Gang Box	999 802	10/120
4 Module Metal Gang Box	999 803	10/120
6 Module Metal Gang Box	999 804	5/80
8 Module Metal Gang Box (H)	999 805	5/60
8 Module Metal Gang Box (V)	999 806	5/60
12 Module Metal Gang Box	999 807	5/45
16 Module Metal Gang Box	999 808	5/45
18 Module Metal Gang Box	999 809	5/40

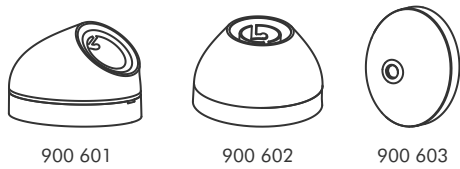

<b>Lamp Holders / Ceiling Rose - Glossy White</b>		
Ova Angle Holder (Virgin PC body)	900 601	20/400
Ova Batten Holder (Virgin PC body)	900 602	20/400
Ova Ceiling Rose (Virgin PC body)	900 603	20/300

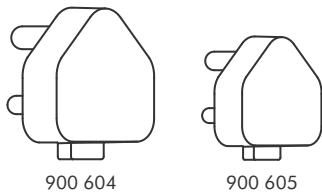

<b>6A / 16A Plano Plugs</b>		
Plano 16A 3 Pin Top (Virgin PC body)	900 604	10/150
Plano 6A 3 Pin Top (Virgin PC body)	900 605	20/300

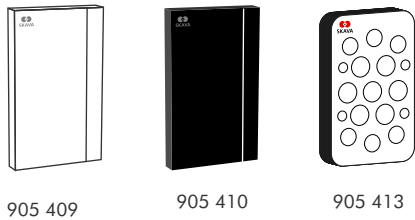

<b>Electronic Zen Bells / Mechanical Ding Dong Bell</b>		
Zen Musical Bells - White <i>32 Selectable Tones &amp; Volume Control Function</i>	905 409	5/50
Zen Musical Bells - Black <i>32 Selectable Tones &amp; Volume Control Function</i>	905 410	5/50
Classic Ding Dong Bell	905 413	10/120

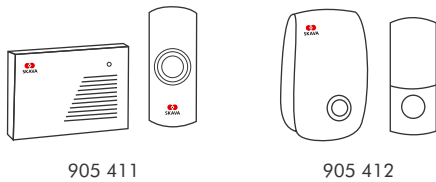

<b>I-mac / Kaya Wireless Bells</b>		
I-mac Wireless Bell <i>2 Selectable Tones</i>	905 411	5/50
Kaya Wireless Bell <i>Plug in Type 32 Selectable Tones</i>	905 412	5/50

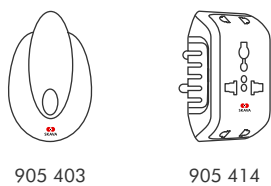

<b>Blossom LED Lamp / Uni. Multi Plug Adaptor</b>		
2 Pin Blossom LED Lamp	905 403	10/100
3 Pin Multi Plug Adaptor	905 414	10/100

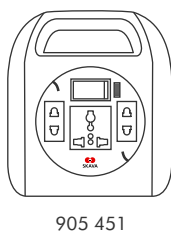

<b>Extension Cord</b>		
Jbox 2 Pin Extension Cord 4 Mtr.	905 451	5/60
Jbox 2 Pin Extension Cord 8 Mtr.	905 452	5/60
Jbox 3 Pin Extension Cord 4 Mtr.	905 453	5/60



We at Skava believe there has to be innovation in every step we take in to the Future. Innovation has driven us for more than a decade & we have been always taking that extra care to improve our products. We take responsibility to give our customers a true experience every time they pick us among all the brands. In fact the competition awaits every new launch from SKAVA as we are deeply obsessed & are driven by this principle of Steve Jobs,

“Innovation distinguishes between the Leader & the follower”.





For any further queries & information  
mail us at : [4u@skava.in](mailto:4u@skava.in)  
or visit : [www.skava.in](http://www.skava.in)

**SKAVA ELECTRIC PVT. LTD.**

#20, Prathibha Industrial Estate,  
Yelachenahalli, Kanakapura Mn Rd,  
Bengaluru - 560 078. India  
Ph : +91 80 2666 8341, +91 98806 60001



For more information Scan the QR Code